

# FYP2

PORTA UNA ANTA BATTENTE  
CON FISSO IN LINEA PER NICCHIA

VETRO TEMPRATO 8MM  
LARGHEZZA DI SERIE L 97<160 CM  
ALTEZZA DI SERIE EFFETTIVA H 200,5 CM  
LE PORTE A MISURA SONO DA 660 FISSO  
PER DIFFERENZA

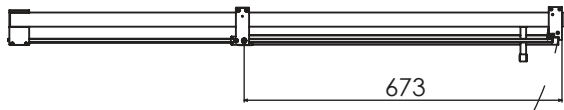

MISURE IN CM DI SERIE	ENTRATA	NUMERO COLLI
97-100	60	2
107-110	60	2
117-120	60	2
127-130	60	2
137-140	60	2
147-150	60	2
157-160	60	2

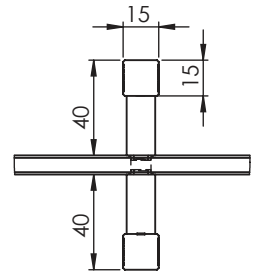
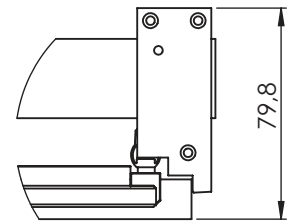
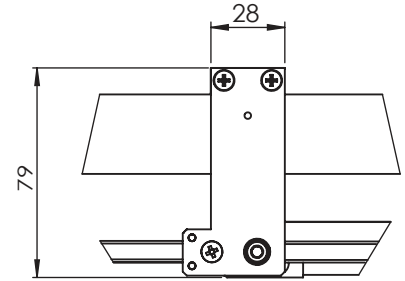
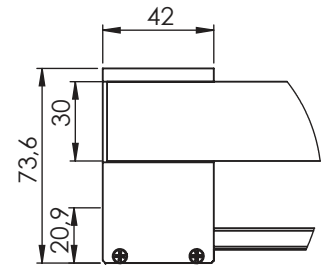
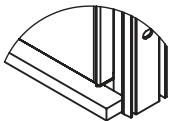
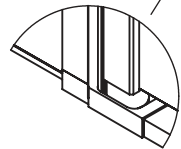
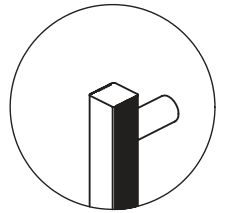
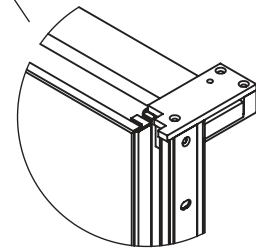
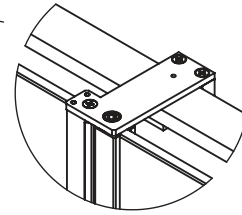
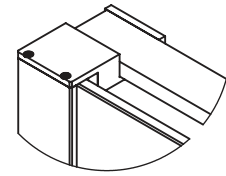
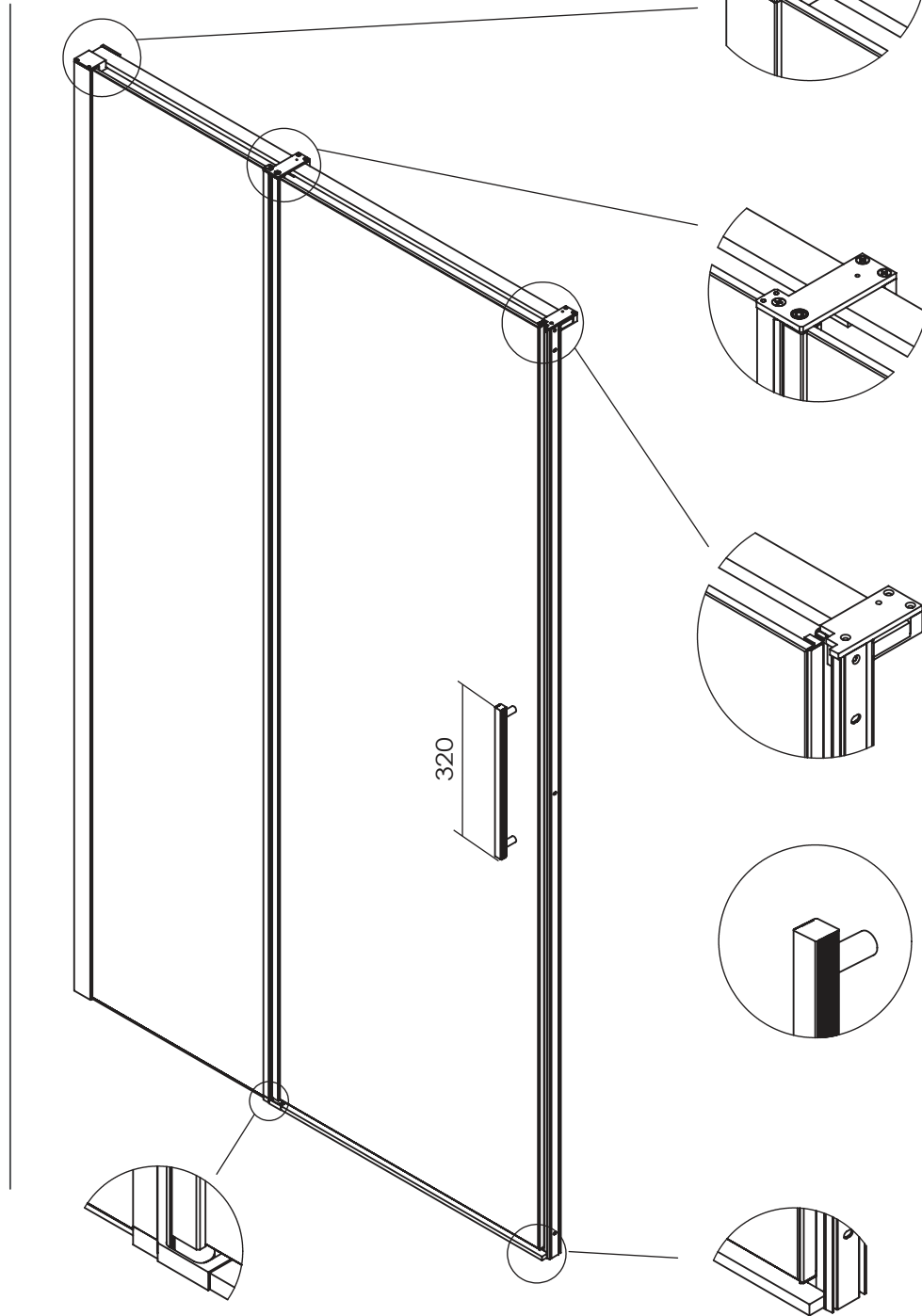

MISURE DISEGNO  
TUTTE IN MM